

Puzzle delle carte da gioco.
 Realizzazione origami di F. Decio
 Disegni di F. Decio

Tassello a «L» corta

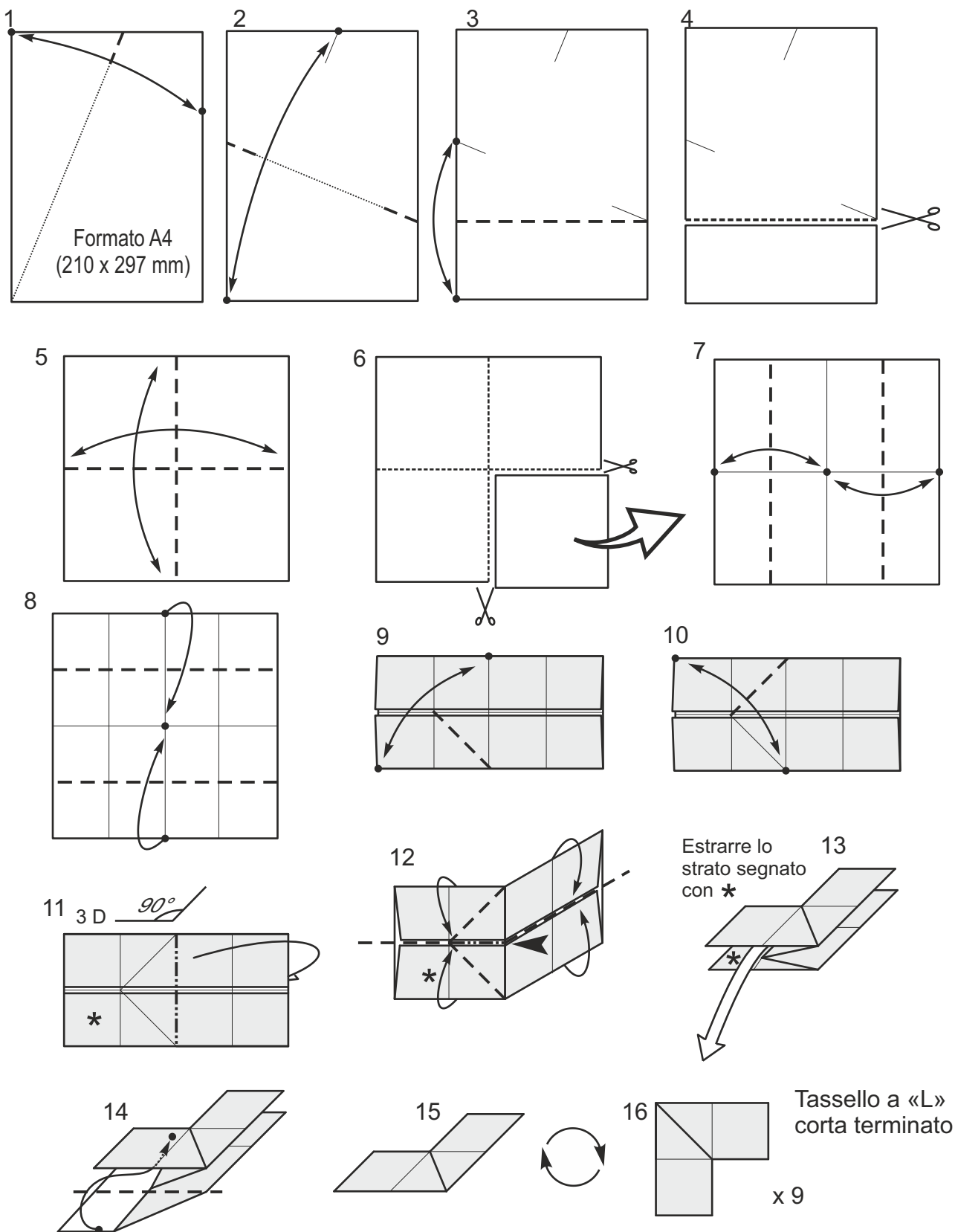



Disegnare un cuore sui vari quadranti di 7 tasselli a «L» corta orientati come indicato di seguito

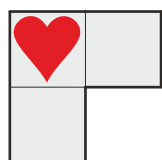

Il tassello n 1

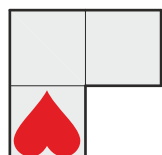

Il tassello n 2

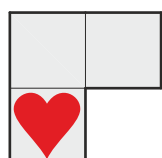

Il tassello n 3

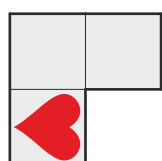

Il tassello n 4

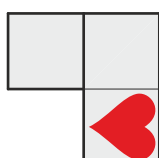

Il tassello
SPECULARE
n. 5

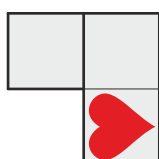

Il tassello
SPECULARE
n. 6

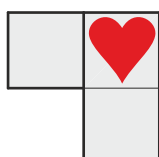

Il tassello
SPECULARE
n. 7

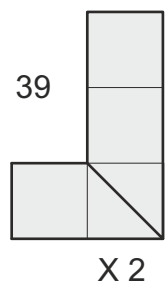
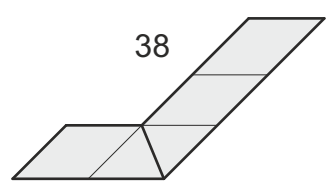
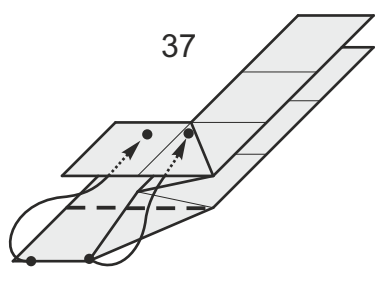
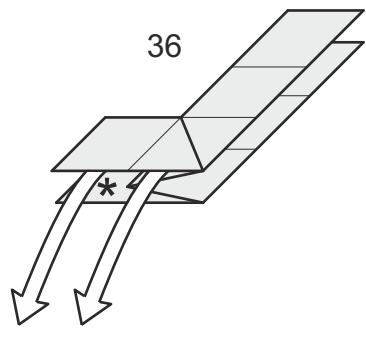
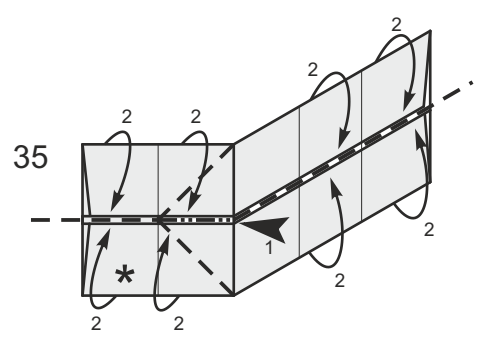
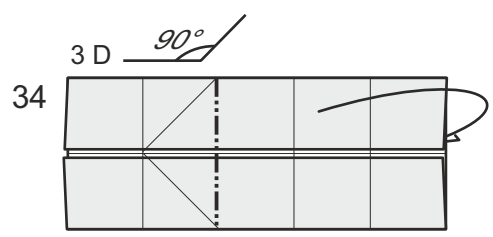
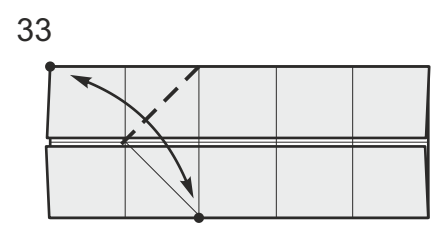
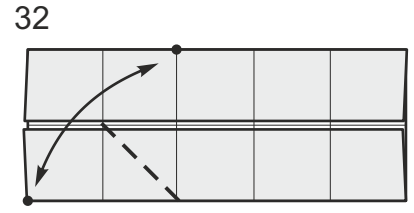
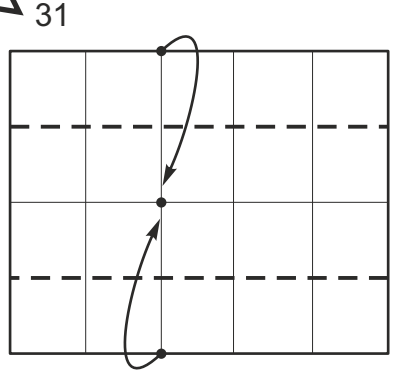

Tassello a «L»
tipo 2 terminato

Piano di gioco 2D

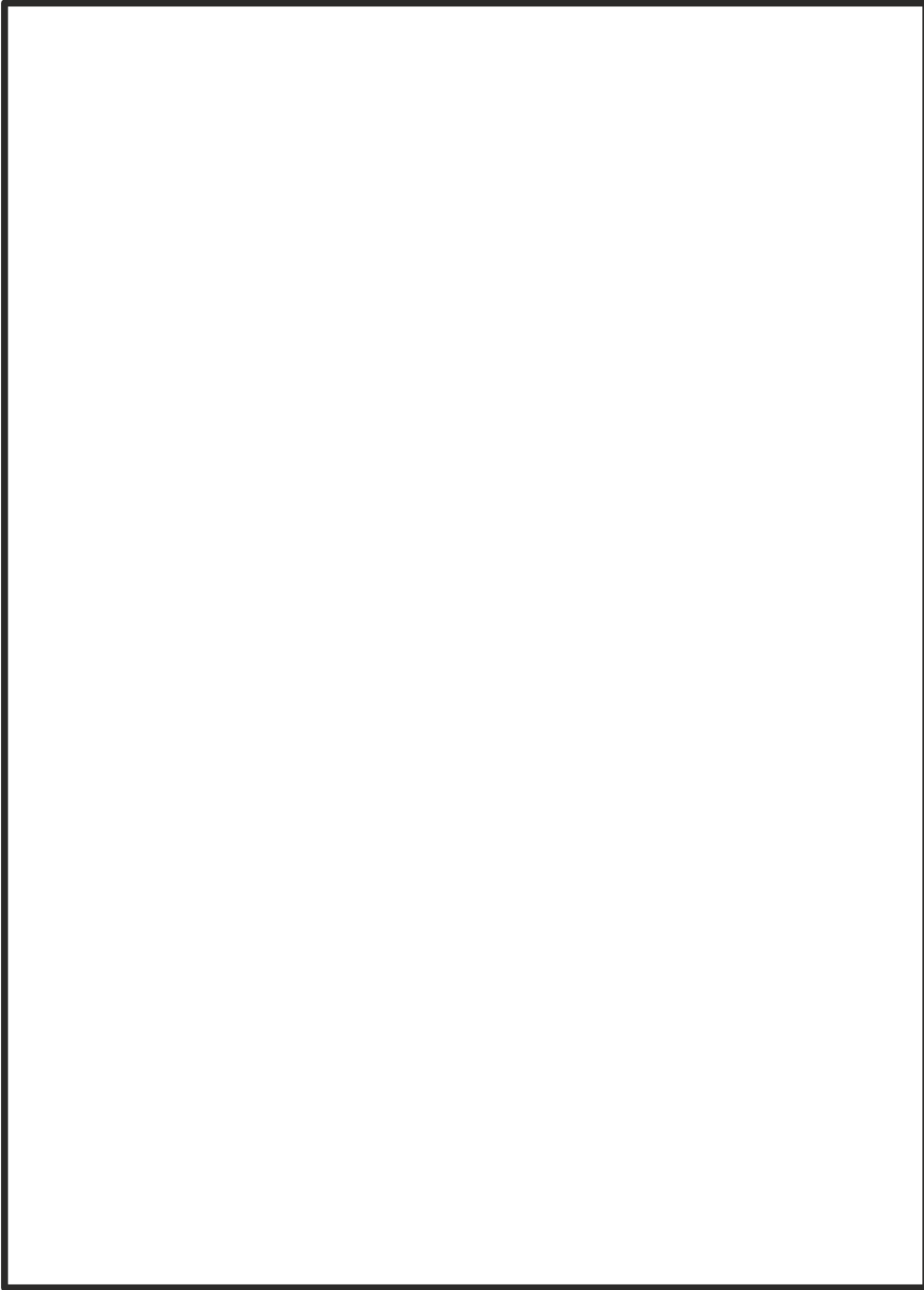

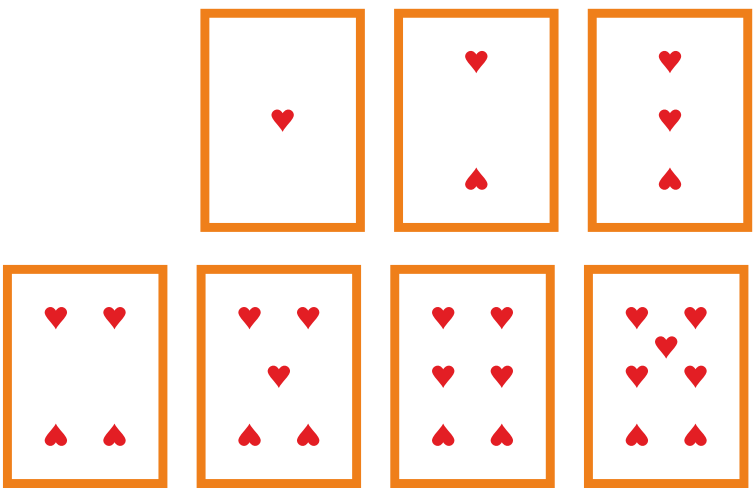
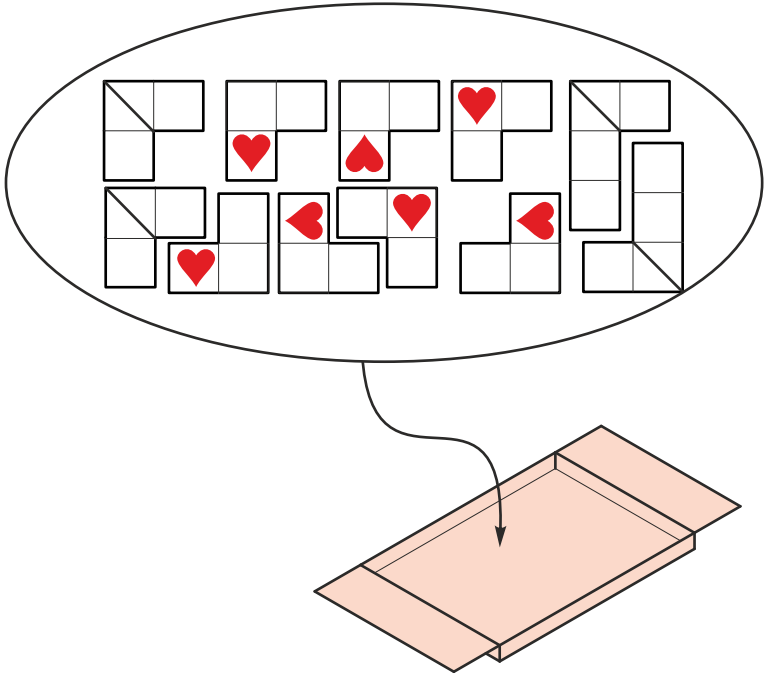

Piano di gioco 3D

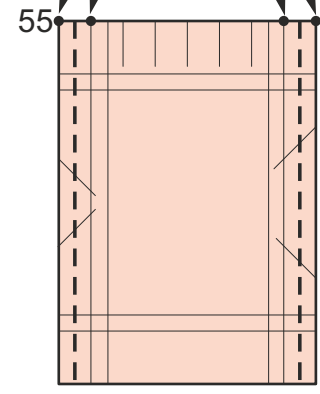
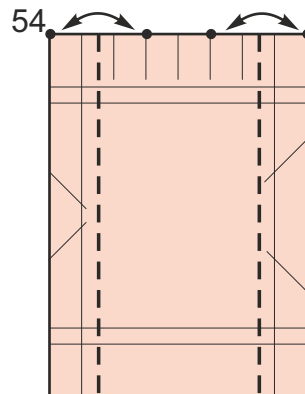
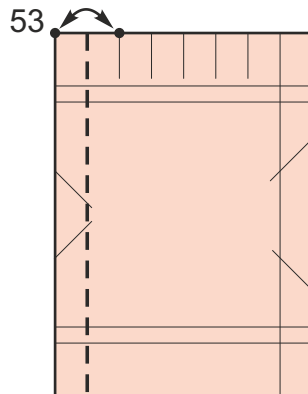
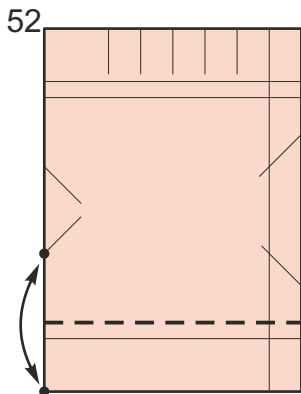
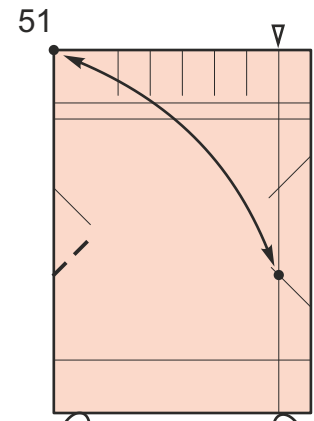
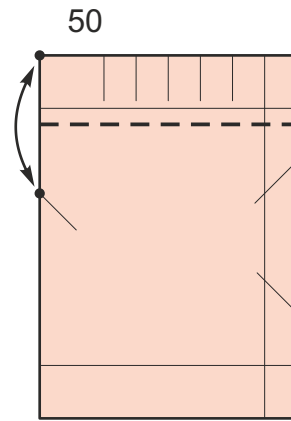
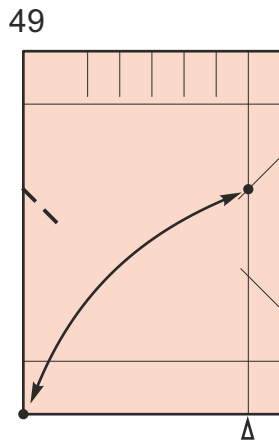
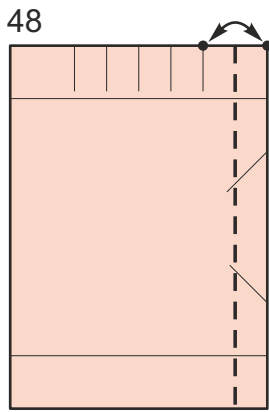
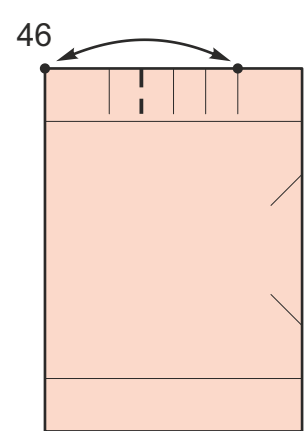
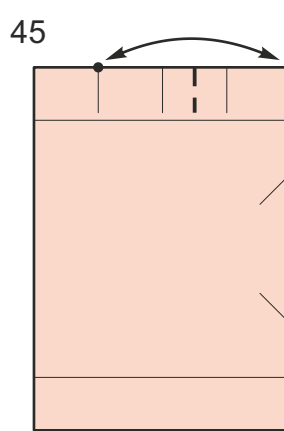
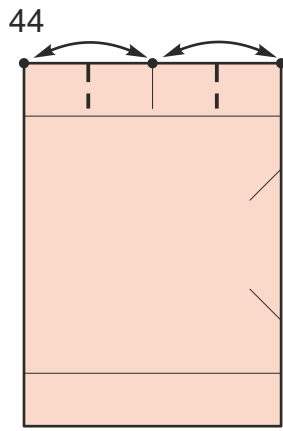
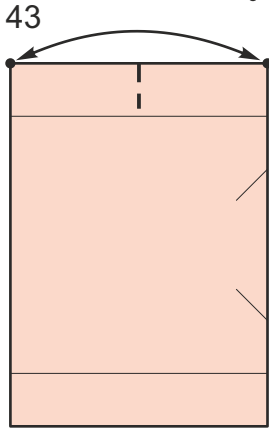
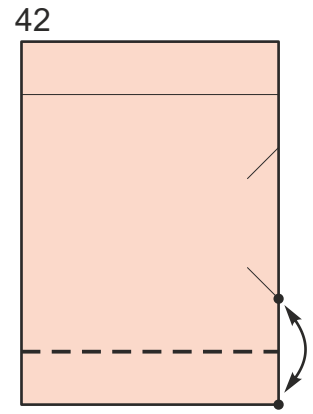
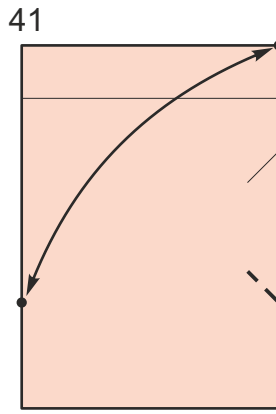
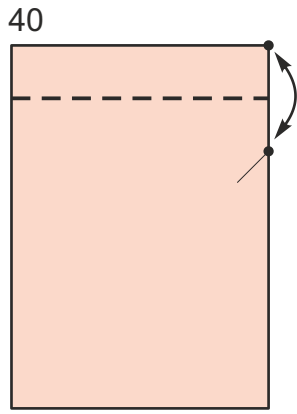
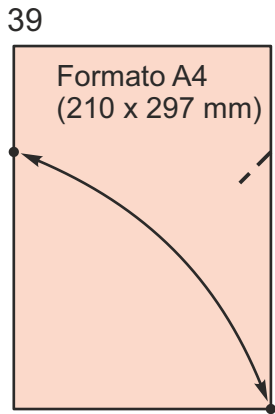

56

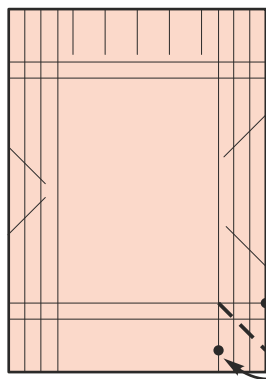

57

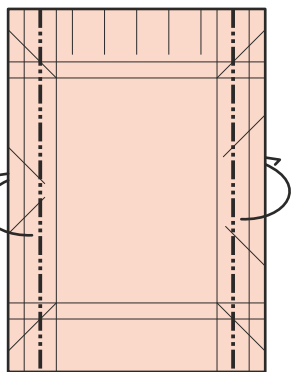

58

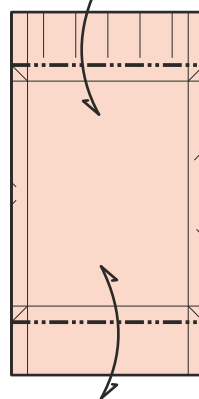

59

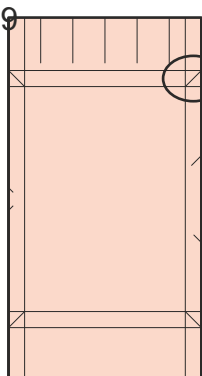

59 a

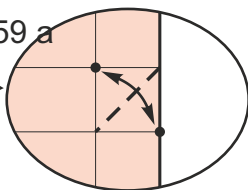

3 D

60

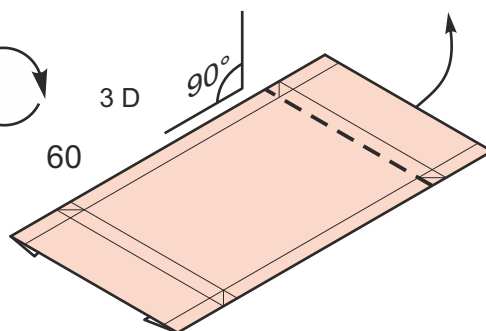

61

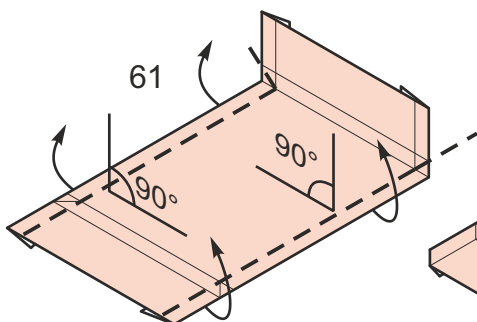

62

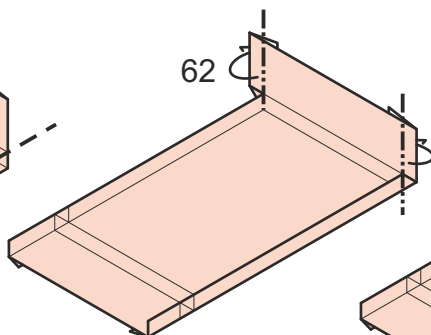

63

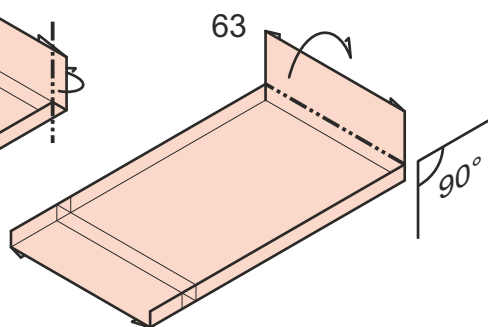

64

60 ÷ 63

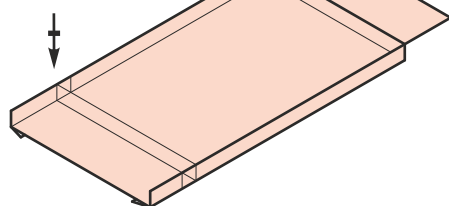

65

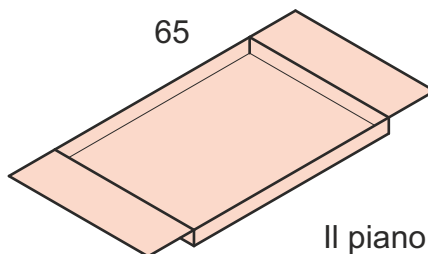

Il piano di gioco 3D terminato